



1 Bilton Road Industrial Estate,
Cadwell Lane, Hitchin,
Herts, SG4 0SB

E info@shy.co.uk

T +44 (0)1462 455400

F +44 (0)1462 437600

www.shy.co.uk

SEZ ELECTRONIC MOTOR OPERATING INSTRUCTIONS



SHY is a member of
the British Blind &
Shutter Association

Electrical connection



Wiring installation must be performed by a qualified electrician. For install and removal of the patch power cord from the main body of the motor (when possible), unplug from the main power supply first to avoid risk of injury from an electric shock.

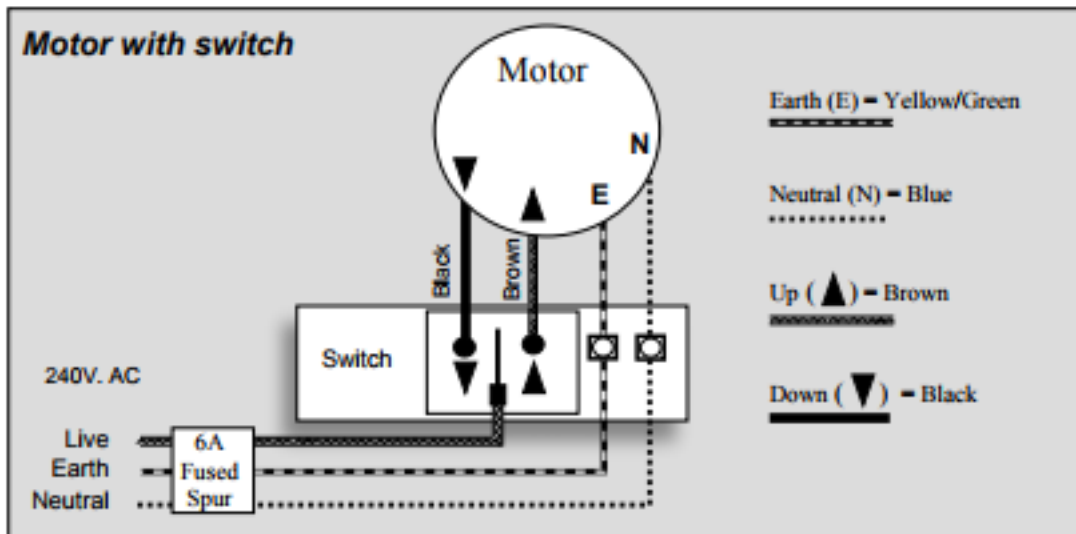

Setting Switch

The 4 wires of the setting switch cable must be connected to the motor cable according to their colours

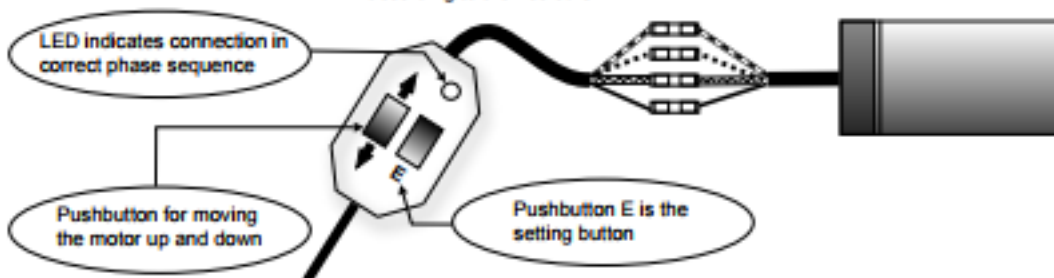

Setup functions

The end positions setting of a SELVE drive is possible via:

- Any standard switch (in automatic mode)
- The setting switch for electronic drives (manual setup-mode).

SEZ (Electronic Motor)

Setting manual limits from the initial switch-on

Using the test switch

1. Connect and switch the power ON.
The test switch LED light will come on.

Setting with test switch



Motor movement

2. Press the E button of the setting switch for 7 seconds.



3. Move the blind down with either the UP or DOWN button. The motor will perform a one-stop start movement. This signifies it is in MANUAL SETTING MODE. The correct rotation assignment will be set at the end of the setting procedure.



4. Once the blind is lowered to the bottom position - press and hold the E button for 4 seconds.



5. Move the blind up to the required TOP end position. Press and hold the E button for 4 seconds.









✓ Limits are now set and the rotation direction assignment is correct. Perform a test run.

SEZ (Electronic Motor)

Setting automatic limits from the initial switch-on

Using the test switch

	Setting with test switch	Motor movement
<p>1. Connect and switch the power ON. The test switch LED light will come on.</p>		
<p>2. The TOP LIMIT must be set first. Move the blind UP with either the UP or DOWN button. The motor will perform a two-stop start movement. This signifies it is in AUTOMATIC SETTING MODE. The correct rotation assignment will be set at the end of the setting procedure. KEEP THE DIRECTION BUTTON PRESSED.</p>		
<p>3. As the blind moves up, the motor will reach the top and stop automatically - setting the upper limit. Continue to keep the same direction button pressed, the motor will now automatically begin to move downwards.</p>		<p>Top stop</p> 
<p>4. The motor will reach the bottom and stop automatically - setting the bottom limit.</p>		 <p>Bottom stop</p>
<p>✓ Limits are now set and the rotation direction assignment is correct. Perform a test run.</p>		

Group control

For the installation of several motors to be grouped and operated using only one control, please ensure that all wiring is correct. Isolate and programme each motor individually using the setting procedure for each one.

SEZ (Electronic Motor)

Setting manual bottom limit with auto top

Bottom limit manual - Top limit automatic stop

Using the test switch

Setting with test switch

Motor movement

1. Connect and switch the power ON.
The test switch LED light will come on.



2. Press the E button of the setting switch for 7 seconds.



3. Move the blind down with either the UP or DOWN button. The motor will perform a one-stop start movement. This signifies it is in MANUAL SETTING MODE. The correct rotation assignment will be set at the end of the setting procedure.

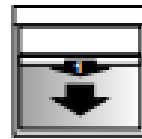

4. Once the blind is lowered to the bottom position - press and hold the E button for 4 seconds to set the bottom limit.



5. Now move the blind UP. Continue to press the direction button, the motor will reach the top and stop automatically - setting the upper limit.



✓ Limits are now set and the rotation direction assignment is correct. Perform a test run.

SEZ (Electronic Motor)

Resetting a motor to factory setting

Reset with test switch

Motor movement

1. Connect and switch the power ON.

2. Press the E button for 1 second on the test switch.
This will put the motor into automatic setup mode and erase the limits.

✓ The motor is now reset to factory setting and in AUTOMATIC MODE AGAIN.



Restart the end positions procedure for manual limit set
• page 2

Restart the end positions procedure for automatic limit set
• page 3

Troubleshooting

Problem	Cause	Solution
Electronic motor does not work	Electric connection defective	Check the connection
	Thermal protection switch has triggered	Wait for 5 to 20 minutes
Motor does not perform the short movements from initial switch-on	Electric connection defective	Check the connection
	End positions are already set	Reset the motor to factory state - page 5
UP and DOWN directions are switched	End positions set incorrectly	Reset end positions
Motor has stopped automatically when moving DOWN	Blockage/obstacle recognition has triggered	Remove obstacle, check side channels
Motor has stopped automatically when moving UP	Overload recognition has triggered	Remove obstacle, check side channels, possibly select stronger motor

Information of all motor types:

Nominal voltage: 230V AC/50Hz

Safety class: IP 44

Operating time: 4 min.

The information contained within these instructions are a guide only. SHY (UK) is not held responsible for wrong installation or improper use during or after setup.