

# 1 FTS to 1 wired in Switch

Motor Cable Identification	
Direction 1	Brown
Direction 2	Black
Brake	Grey
Neutral	Blue
Earth	Yellow/Green

Black and Brown connection will vary according to system set-up.

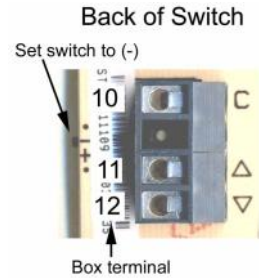
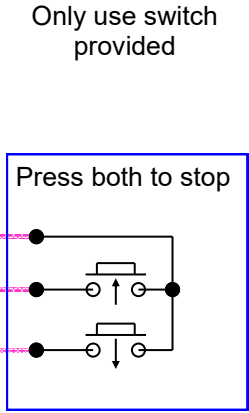
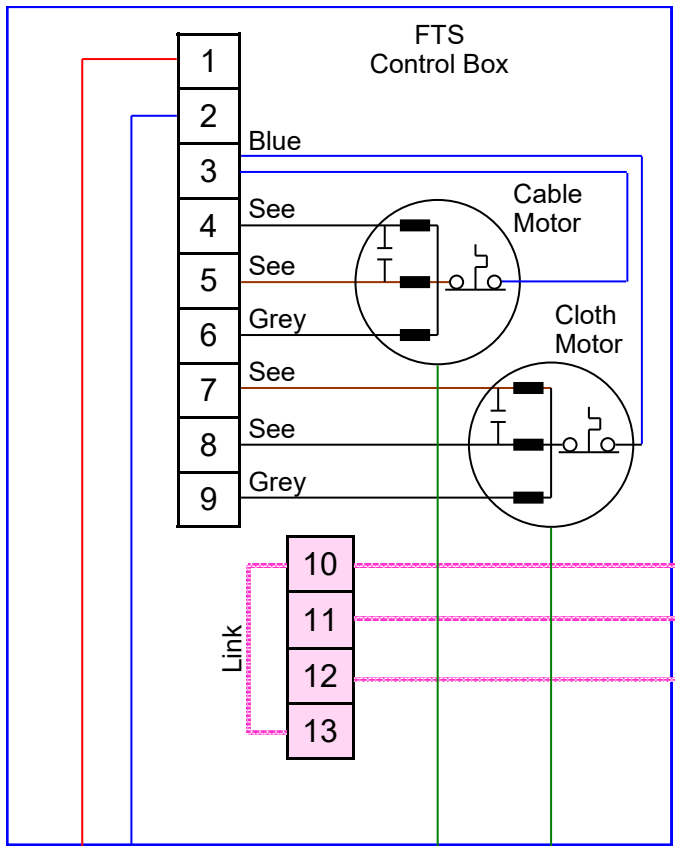
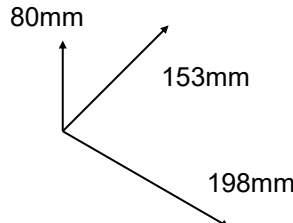

**Never Connect more than One Blind into One Control Box**

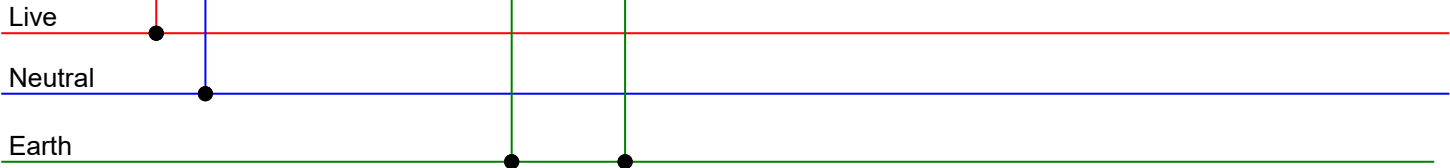
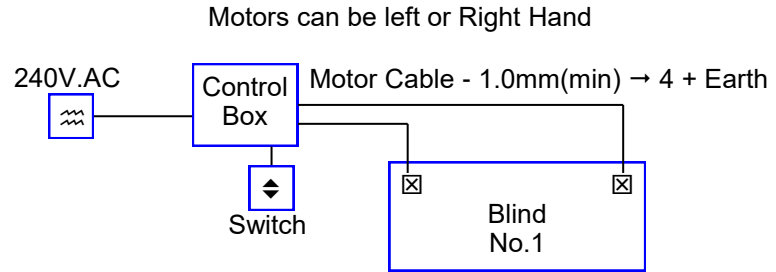

Low Voltage

**Tip:**

- Always make sure the control box is accessible for setting up the blind and for future maintenance (fitting the control box so it is inaccessible when the blind is closed is not a good idea).

1 FTS to 1 wired in Switch  
Black and Brown identification & connection

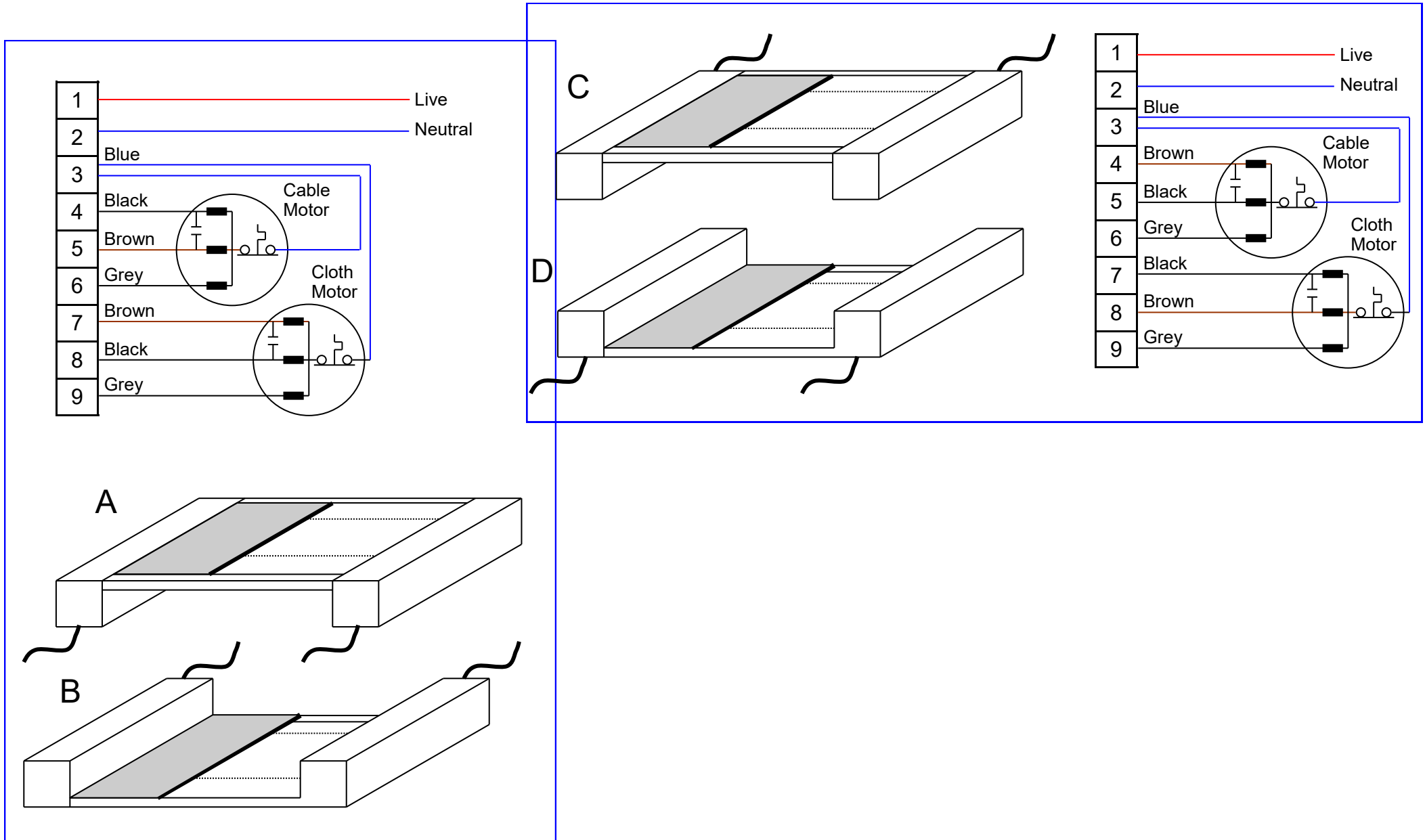

1 FTS to 1 wired in Switch  
Black and Brown identification & connection

